

Inhalt
Contents
Contenu

Inhoud
Contenido
Conteúdo

Einzelteilübersicht / Spare parts list / Liste des pièces détachées / Onderdelenoverzicht / Lista da piezas / Resumo de peça individual S. / p. 1

Montagetipps / Tips for assembly / Tuyaux pour le montage / Montagetips / Consejos para el montaje / "Dicas" para montagem S. / p. 2

Ausflugsschiff mit Anleger / Excursion ship with landing pier /
 Navire d'excursions avec quai d'amarrage / Excursieboot met aanlegplaats /
 Embarcación de recreo con embarcadero / Barco de passeio com atracadouro . . . S. / p. 4

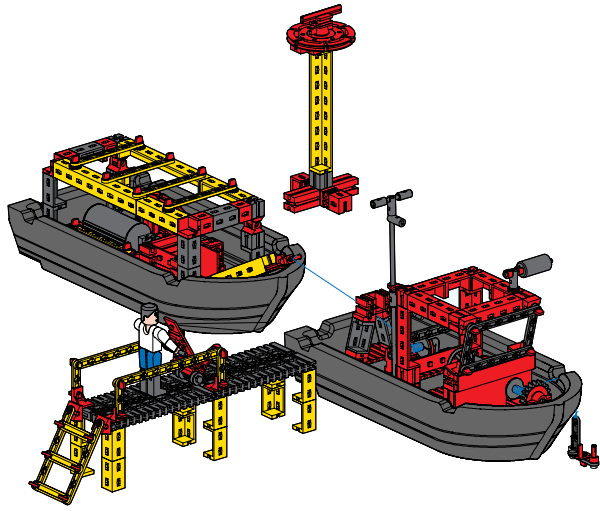
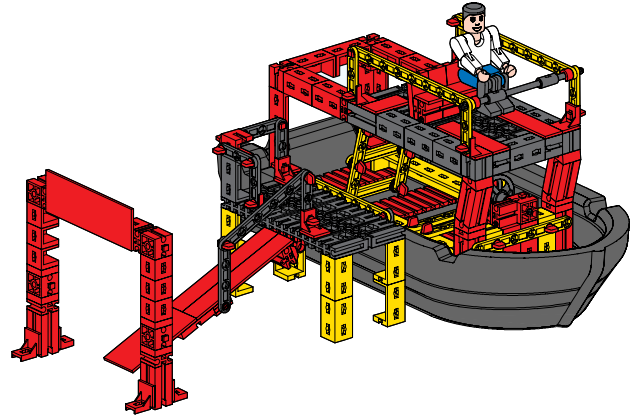

Hafenschlepper mit Schute / Harbor tug with barge /
 Remorqueur portuaire avec barge / Havensleper met schuit /
 Remolcador de puerto con barcaza / Rebocador com batelão S. / p. 10



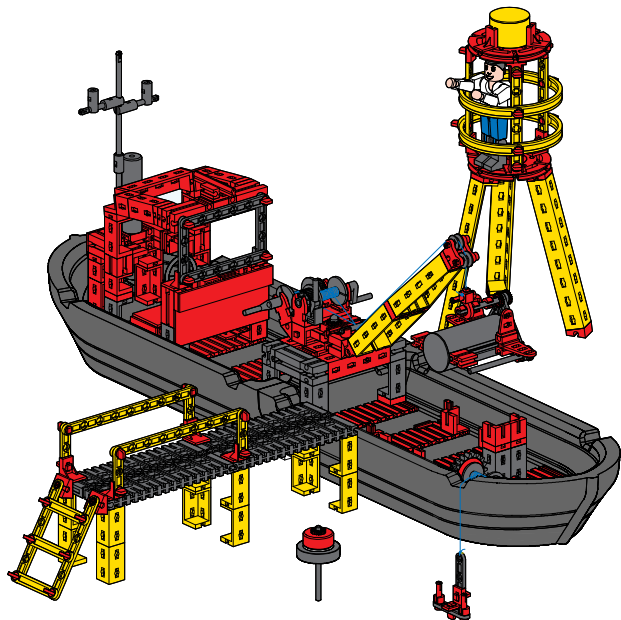
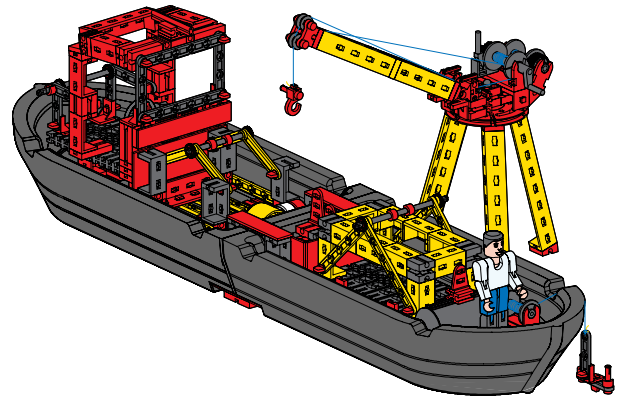







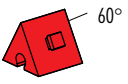

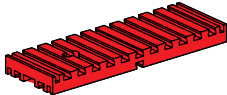

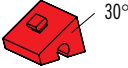

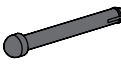
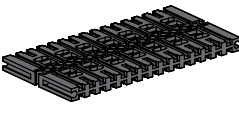

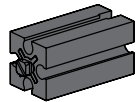
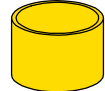



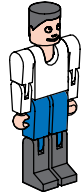











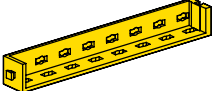

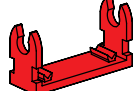
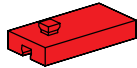
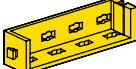

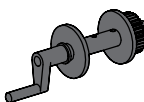
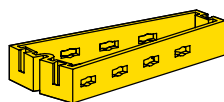







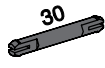

Frachtschiff und Kran / Cargo ship and crane / Cargo et grue /
 Vrachtschip en kraan / Buque de carga y grúa / Navio de carga e guincho . . . S. / p. 19



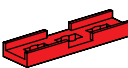
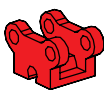
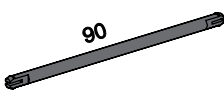



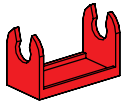
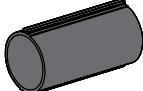

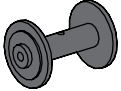

Forschungsschiff und Hafen / Research ship and harbor /
 Bâtiment océanographique et port / Onderzoeksschip en haven /
 Buque de investigación y puerto / Navio de pesquisa e porto S. / p. 27

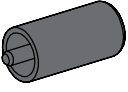

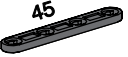



Einzelteilübersicht
Spare parts list
Liste des pièces détachées

Onderdelenoverzicht
Lista da piezas
Resumo de peça individual





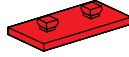
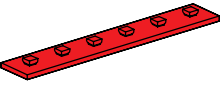
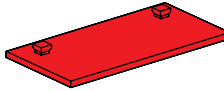
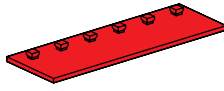



 60°	31 010 2 x		31 690 6 x		32 859 8 x		35 073 3 x
 30°	31 011 2 x		31 707 1 x		32 870 1 x		35 129 2 x
	31 019 2 x		31 848 4 x		32 879 2 x		35 409 1 x
	31 021 1 x		31 916 1 x		32 881 5 x		35 806 1 x
	31 027 1 x	 15°	31 981 6 x		34 994 1 x		35 980 3 x
	31 058 2 x		31 982 19 x		34 995 1 x		36 227 4 x
 15	31 060 6 x		31 994 1 x		35 031 2 x		36 294 3 x
 30	31 061 1 x		31 997 2 x		35 049 5 x		36 297 2 x
	31 124 1 x		31 998 2 x		35 052 1 x		36 299 12 x
 45	31 330 1 x		31 999 1 x	 120	35 060 2 x	 4	36 323 28 x
	31 426 2 x		32 064 5 x	 30	35 063 2 x	 6	36 324 10 x
	31 436 2 x	 7.5°	32 071 6 x	 45	35 064 1 x		36 334 8 x
	31 668 1 x		32 085 1 x	 90	35 066 2 x		36 581 1 x
	31 670 1 x	 75	32 200 6 x		35 069 1 x		36 702 1 x
	31 674 12 x		32 851 1 x		35 070 1 x		



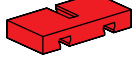
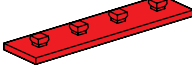

Einzelteilübersicht
Spare parts list
Liste des pièces détachées

	36 703 2 x
	36 906 2 x
	36 912 4 x
	36 913 4 x
	36 914 4 x
	36 920 10 x
	36 923 3 x
	37 034 10 x
	37 237 8 x
	37 238 8 x

	37 468 18 x
	37 679 8 x
	38 225 1 x
	38 240 13 x
	38 241 22 x
	38 245 2 x
	38 249 1 x
	38 251 1 x
	38 253 3 x
	38 258 2 x

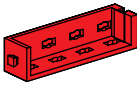
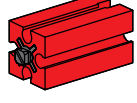
Onderdelenoverzicht
Lista da piezas
Resumo de peça individual

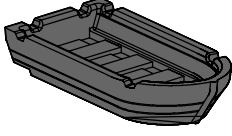
	38 260 2 x
	38 413 1 x
	38 415 1 x
	38 416 3 x
	38 423 7 x
	38 428 2 x
	38 464 3 x
	38 538 4 x
	38 542 4 x
	38 545 10 x

	78 728 3 x
	116 251 6 x
	116 252 4 x
	126 927 2 x
	127 471 8 x
	127 472 6 x

Montagetipps
Tips for assembly
Tuyaux pour le montage

Seile Touwen
 Cables Cables
 Câbles Cordas



350 cm

Montagetipps
Consejos para el montaje
"Dicas" para montagem

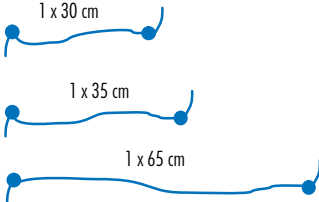

1 x 30 cm
 1 x 35 cm
 1 x 65 cm

Knoten verhindert ausfransen
 Knots prevent fraying
 Le noeud empêche l'effilochage
 Knopen voorkomen het uitrafelen
 Nudos impiden el deshilachado
 Nó para evitar a desintegração da corda